

S-5-Z Mini

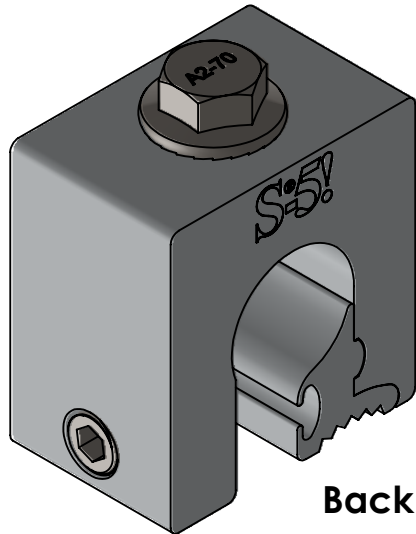

Back

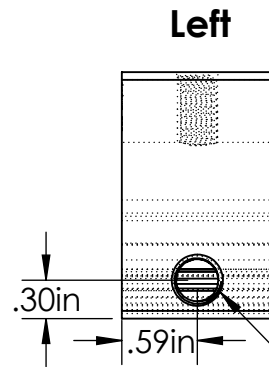
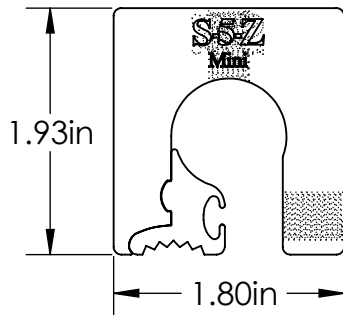
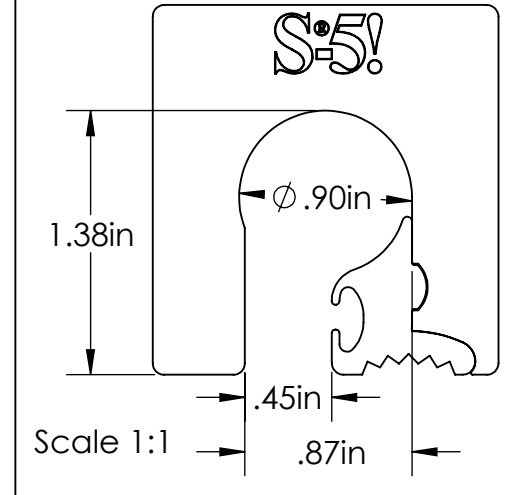
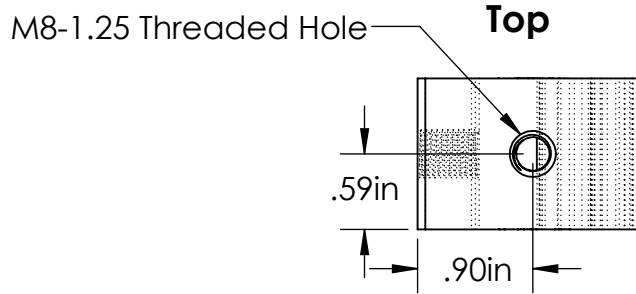

Left

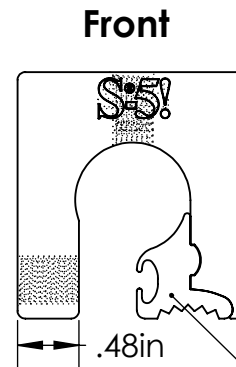

Front

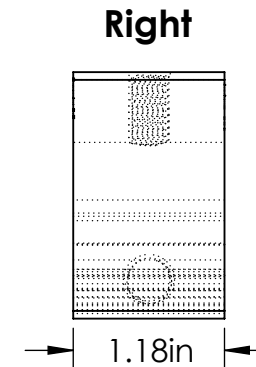

Right

3/8-24 Threaded Hole S-5-T Mini Insert

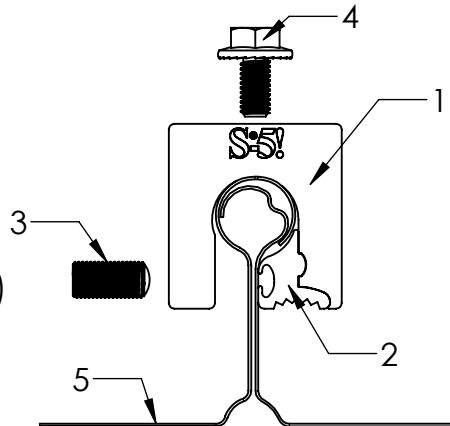

General Notes:

1. S-5-Z Mini Clamp
2. S-5-Z Mini Insert
3. 3/8-24 SS Round Point Setscrew (3/16 Hex Drive)
4. M8-1.25 SS Hex Flange Bolt (13mm Socket)
5. Example Roof

FOR STANDING SEAM SPECIFIC MECHANICAL LOAD TEST INFORMATION AND CLAMP INSTALLATION INFORMATION PLEASE VISIT: WWW.S-5.COM

MATERIAL: 6061 T6 Al			METAL ROOF INNOVATIONS, LTD. 8655 TABLE BUTTE RD COLORADO SPRINGS, CO 80908 719-495-0518 719-495-0045(FAX)	
EST ASSEMBLY WEIGHT: 0.329 lbs			TITLE S-5-Z Mini	
SUPPLIED HARDWARE: M8-1.25 x 16 mm Bolt 3/8-24 x .800" Setscrew	DRAWING NO. Z12-A-1-C	DRAWN BY Kati Kadakas	DATE 4/12/2016	
SCALE: 1:1.5	S-5!® PRODUCTS ARE PROTECTED BY MULTIPLE U.S. AND FOREIGN PATENTS. VISIT OUR WEBSITE AT WWW.S-5.COM FOR COMPLETE INFORMATION ON PATENTS AND TRADEMARKS.			